

POS-300N+ / POS-300ND+



User Manual



Contents

1. General Description	3
2. Installation and use Description	4
2.1 Preparation	4
2.2 Use	4
2.3 Front panel control	5
3. External Description	10
3.1 Front Panel	10
3.2 Rear Panel	11
3.3 Connector Description	12
4. Technical Specifications	13
4.1 Physical specifications	13
4.2 Electrical specifications	13
5. Working Principles	15
5.1 Power Supply	16
5.2 Main Board	16
5.3 Control Board	16
5.4 Audio & VCO Board	16
5.5 Audio Connector	17
5.6 Interface Connector	17
5.7 Power Amplifier Board	17

1. General Description

The POS-300N series is transmitter for Frequency Modulated audio broadcasting in a frequency modulation able to transmit in the band between 87.5 and 108 MHz with an output RF power adjustable up to a maximum of 300 W

Outstanding audio features this device has are low distortion and inter modulation values and the high signal to noise ratio. Another important feature the POS-300N series has is its great simplicity of construction and use.

The POS-300N series was designed to be modular. Its various functions are run from modules directly connected to each other with male and female connectors or with flat cables ending in connectors. This type of design makes maintenance operations and any required module replacement easier. All models are made with SMD technology.

This exciter contains a low-pass filter that reduces the harmonic emissions to below the limits allowed by international regulations, and can therefore be used as a transmitter connected directly to the antenna.

The machine is offered in two versions, one for Mono or MPX input (wideband input that is useful when you want to transmit in stereo using an external stereo encoder) and the other with an integrated stereo encoder. The POS-300N stereo encoder guarantees excellent stereo separation together with a low harmonic distortion level. Also the stereo version of the exciter can be configured for operating in Mono/MPX mode (meaning excluding the stereophonic coder and using the "left" input as the "mono" input and the BNC as the "MPX").

The user can do the configuration through micros witches that are accessible from the outside. Both versions have two inputs (SCA1 and SCA2) for modulated signals on sub carriers from special external encoders normally used in Europe for RDS (Radio Data System) transmission.

The microprocessor system includes an LCD display and push-button panel for inter action with the user, and implements the following functions:

- Setting the output power
- Setting the operating frequency
- Measurement and display of the working parameters of the exciter

The exciter's management software is based on a menu system. The user can navigate between the various submenus by using four push buttons: UP, DOWN, LEFT, RIGHT and ENTER.

2. Installation and use Description

This chapter contains the necessary information for installing and using the machine. In the event any aspects are not completely clear, for example when using the machine for the first time, we recommend you carefully read the entire description contained in this manual.

2.1 Preparation

Unpack the exciter and before doing any other operation, be sure it has not been damaged during transport. In particular check that all the connectors are in perfect condition.

The main fuse can be accessed from the outside on the rear panel. Extract the fuse carrier with a screwdriver to check its integrity or for replacement, if necessary. The fuse to be used is this type 5A @220VAC

Check that the POS-300N switches are in the "OFF" position. The exciter has one switch for the mains power supply cable and completely interrupts the machine's mains power supply.

Connect the RF output of the exciter to the antenna cable or to a fictitious load 50 ohm.

Connect the mains cable.

Connect the earth cable.

Connect the audio cables of the signal source to the proper connectors on the back of the exciter.

2.2 Use

Check that the POS-300N switches are in the "ON" position.

Enter the "ESC" menu and "ENTER" to set the desired operating frequency.

By using the switches and trimmer found on the rear panel, set the characteristics (impedance, pre emphasis and, if it's necessary, stereo/mono) and the levels of the audio and RDS input.

Set the desired power level from the LCD menu.

2.3 Front panel control

The machine is provided with a two-line LCD display where a set of menus is shown

When turned on, the LCD display shows the predefined screen with the graphic representation of the instantaneous modulation level and indication of the direct power supplied:

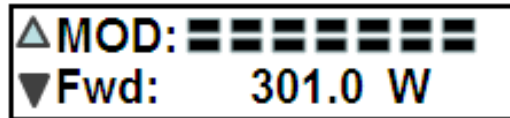

The vertical bars under "MOD" indicate the progress of the modulation in real time; the hatched bar signals the maximum nominal modulation level of 75 kHz (100%).

To change the menu, select the UP or DOWN push button, the screen that is shown in following:

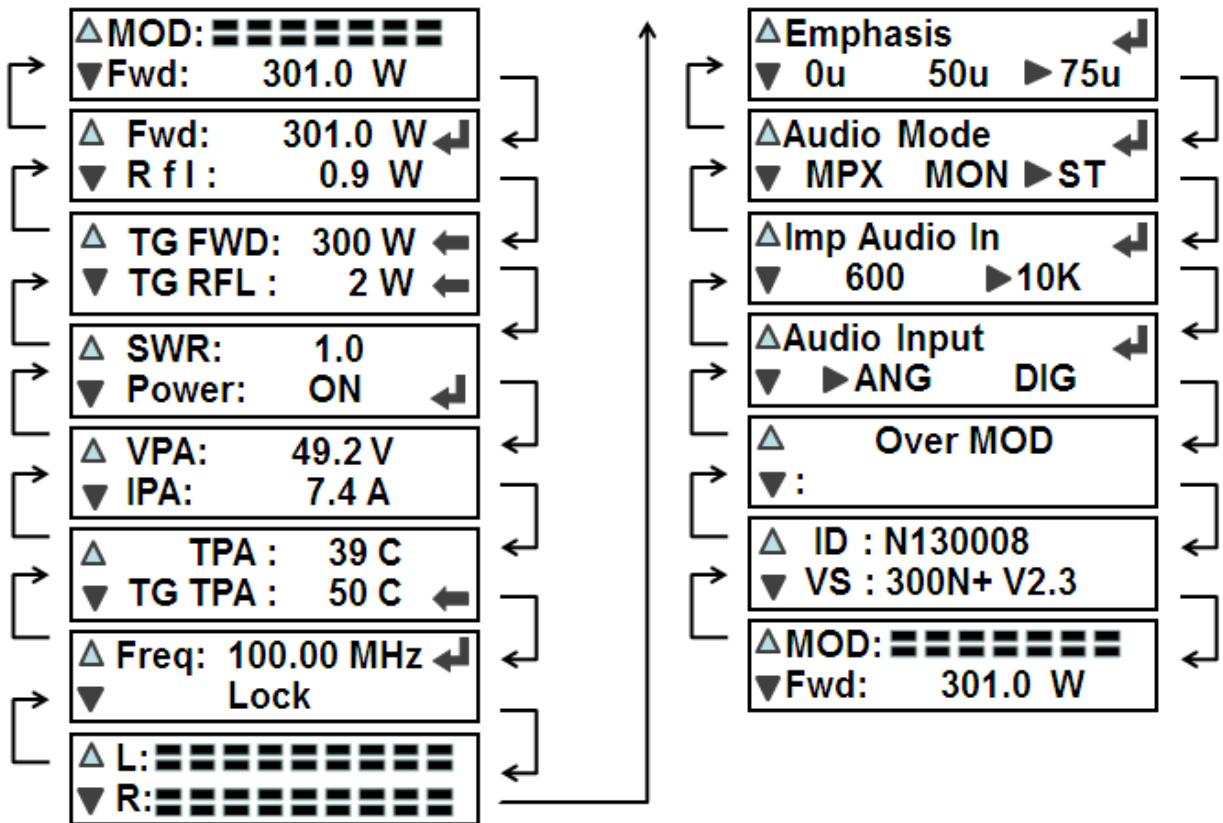

***Symbol:

- ▲ (UP) change parameter display on LCD
- ▼ (DOWN) change parameter display on LCD
- ◀ (LEFT) decrease value as setting
- ▶ (RIGHT) increase value as setting
- ↵ (ENTER) select to value change value
- ⏪ (SET) value set by software

2.3.1 Power setting

To change the set power level, select the menu power as below,

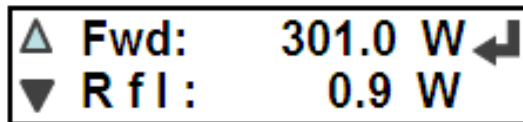

Keep the ENTER push button. The screen that is show in the modification mode is similar to the following:

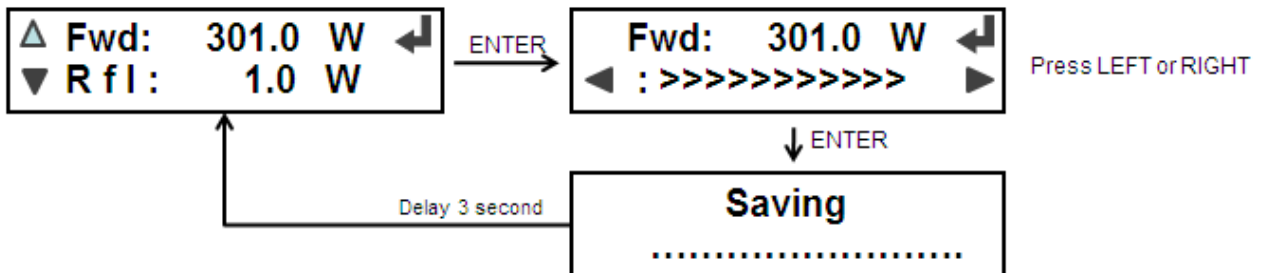

To increase the level, press the RIGHT push button and to reduce it, press LEFT. As the set level increases or decreases, the bar becomes longer or shorter to display the current setting. When the designed level is reached, press ENTER to confirm and exit the predefined menu.

2.3.2 RF Power ON/OFF

To change the RF power ON or OFF, select the menu power as below,

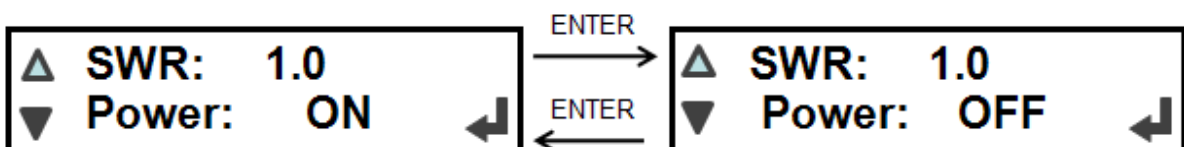

2.3.3 Frequency setting

This menu lets you read and set the operating frequency.

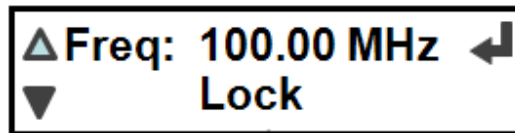

Keep the ENTER push button. The screen that is show in the modification mode is similar to the following:

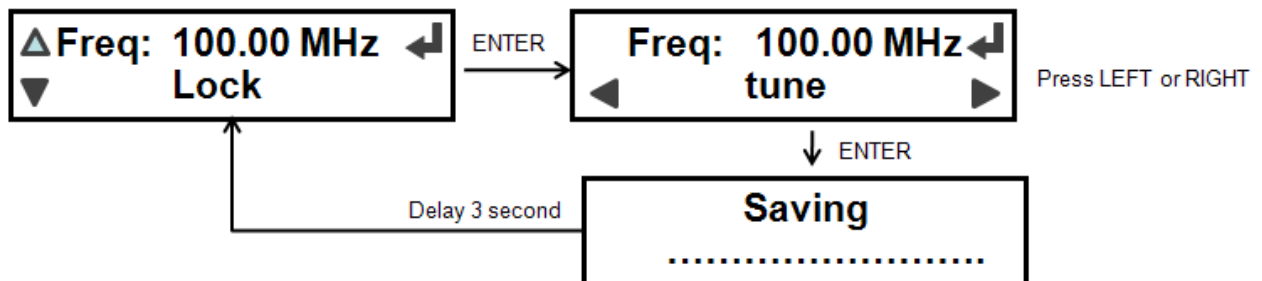

By pressing the ENTER push button, you can modify the set frequency using the RIGHT (the frequency increases) and LEFT push buttons. After having set a new frequency value, press the ENTER push button to confirm the choice. The exciter will release from the current frequency and it will latch onto the new operating frequency.

2.3.4 Pre Emphasis setting

This menu lets you read and set the pre emphasis.

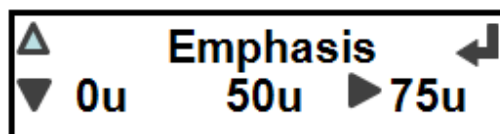

Keep the ENTER push button. The screen that is show in the modification mode is similar to the following:



By pressing the ENTER push button, you can modify the pre emphasis using the RIGHT and LEFT push buttons. After having set a new pre emphasis value, press the ENTER push button to confirm the choice.

2.3.5 Audio Mode setting

This menu lets you read and set the audio mode.

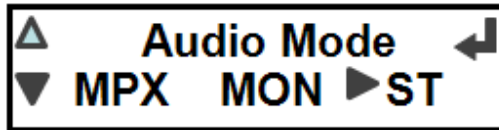

Keep the ENTER push button. The screen that is show in the modification mode is similar to the following:



By pressing the ENTER push button, you can modify the audio mode using the RIGHT and LEFT push buttons. After having set a new audio mode value, press the ENTER push button to confirm the choice.

2.3.6 Audio Input Impedance setting

This menu lets you read and set the audio input impedance.

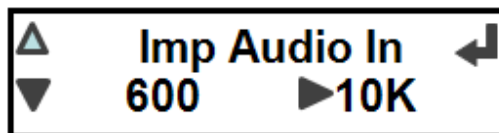

Keep the ENTER push button. The screen that is show in the modification mode is similar to the following:



By pressing the ENTER push button, you can modify the audio input impedance using the RIGHT and LEFT push buttons. After having set a new audio input impedance value, press the ENTER push button to confirm the choice.

2.3.7 Audio Input type setting

This menu lets you read and set the audio input type.



Keep the ENTER push button. The screen that is show in the modification mode is similar to the following:



By pressing the ENTER push button, you can modify the audio input type using the RIGHT and LEFT push buttons. After having set a new audio input type value, press the ENTER push button to confirm the choice.

Note: for mode DIG, this reserve for digital audio input (AES/EBU) option on request.

3. External Description

This chapter reports the elements of the front and rear panels of the POS-300N series with a brief description of each of them.

3.1 Front Panel



- | | |
|--------------|--|
| [1] AIR FLOW | Grid for the intake of the air flow of the forced ventilation |
| [2] POWER | ON/OFF switch. This switch disables the exciter without disconnecting the mains supply |
| [3] ON | Green LED, light when the exciter is working |
| [4] LOCK | Green LED, light when the PLL is locked on the working frequency |
| [5] OVER MOD | Yellow LED, light when the modulate audio signal more than +- 75 KHz |
| [6] ALARM | Red LED, light when the alarm function is operating (high reflect power, high SWR or high temperature) |
| [7] RF ON | Green LED, light when the exciter's power output is on. |
| [8] LEFT | Push button to decrease value. |
| [9] UP | Push button to change parameter display |
| [10] RIGHT | Push button to increase value. |
| [11] DISPLAY | Liquid crystals display |
| [12] DOWN | Push button to change parameter display |
| [13] ENTER | Push button to confirm a parameter. |

3.2 Rear Panel

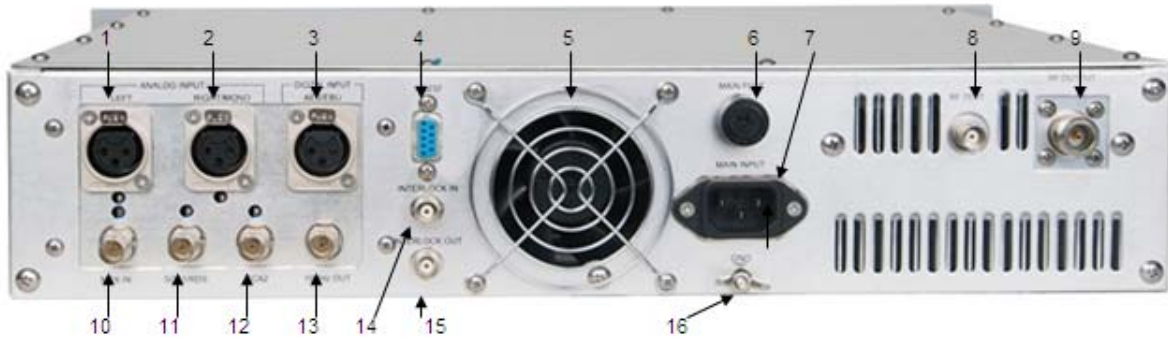

- | | |
|--------------------|---|
| [1] LEFT | XLR connector, balanced Left channel input.
And adjustment trimmer for Left channel input level on bottom connector |
| [2] RIGHT/MONO | XLR connector, balanced Right channel input
And adjustment trimmer for Right channel input level on bottom connector |
| [3] AES/EBU | XLR connector, Digital audio input (optional) |
| [4] RS232 | DB9 connector for interconnection with other devices and for parameters programming |
| [5] AIR FLOW | Grid for the intake of the air flow of the forced ventilation |
| [6] FUSE | Fuse holder. Use a screwdriver to access the fuse Contains the general protection fuse rated 5 A |
| [7] PLUG | Mains supply plug, 200 - 260V 50-60 Hz |
| [8] RF TEST | RF test output |
| [9] RF OUTPUT | RF output connector, N-type, 50Ω. |
| [10] MPX | BNC connector, MPX unbalanced input.
And adjustment trimmer for MPX input level on top connector |
| [11] SCA1/RDS | BNC connector, SCA1/RDS unbalanced input.
And adjustment trimmer for SCA input level on top connector |
| [12] SCA2 | BNC connector, SCA2 unbalanced input.
And adjustment trimmer for SCA input level on top connector |
| [13] 19 KHZ OUT | BNC output for the 19 kHz pilot tone. This can be used for external devices (e.g. RDS coders) synchronization |
| [14] INTERLOCK IN | BNC interlock in connector: the exciter is forced in stand-by mode when the inner conductor is grounded. |
| [15] INTERLOCK OUT | BNC interlock out connector: the inner short to ground when alarm is on. |
| [16] GND | Ground of equipment, connect to earth |

3.3 Connector Description

3.3.1 RS 232

Type: DB9 female

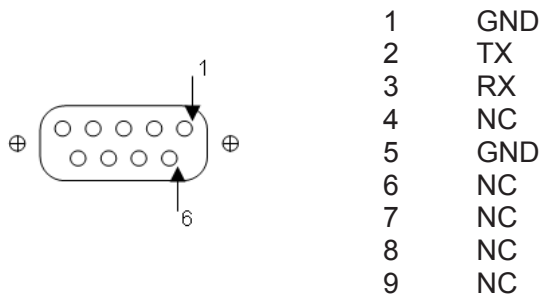

3.3.2 Audio input LEFT/RIGHT

Type: XLR female

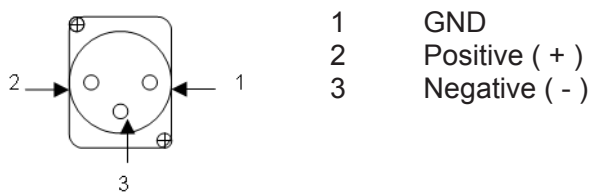

4. Technical Specifications

4.1 Physical specifications

Panel size	485 mm (19") x 88 mm (2U)
Depth	550 mm
Weight	14 Kg
Working Temperature	0 °C ÷ 50 °C

4.2 Electrical specifications

General

RF output power	0 to 300 W, adjustable
RF output connector	N – type female
RF output impedance	50 Ohm
Frequency range	87.5 MHz ÷ 108 MHz
Frequency setting	software programming
Frequency step	10 KHz
Frequency stability	< ±300Hz from -10°C to 50°C
Modulation type	direct carrier modulation
Harmonics	< -75 dBc
Out of Band Emission (Spurious)	< -85 dBc
Modulation capability	< +- 75KHz
A.C. power supply	≅ 200 V ÷ 260 V
Power consumption	700 VA

Input

Left, Right and Mono Input	Type: XLR female balanced
MPX input	Type: BNC, unbalanced
Input impedance	balanced input: 600 or 10 k Ohm selectable
MPX input impedance	unbalanced input 10 k Ohm
Input level	-6 dBm ÷ +12 dBm, adjustable
Pre emphasis	Selectable: 0 50 us (CCIR) 75 us (FCC)
SCA/RDS input	2 BNC unbalance
SCA/RDS input impedance	10 kOhm
SCA/RDS input level	-6 dBm ÷ +12 dBm, adjustable
SCA/RDS amplitude/frequency response	± 0.2 dB, 40 kHz to 100 kHz

Output

RF Out	N – type female, 50 Ohm
RF test	BNC connector
19 kHz pilot tone output	BNC connector, 1.3 Vp-p.



MONO operation

S/N > 70dB
Amplitude frequency response ± 0.5 dB, 20Hz ÷ 15 KHz
Total harmonic distortion (THD) < 0.3%

MPX operation

Composite S/N > 70dB
MPX amplitude frequency response ± 0.1 dB, 20 Hz ÷ 53 KHz
 ± 0.2 dB, 53 KHz ÷ 100 KHz
MPX Total harmonic distortion (THD) < 0.3 %
Stereo separation > 50 dB

Stereo operation

S/N FM Stereo > 70 dB
Audio frequency response 20 Hz ÷ 15 KHz
Total harmonic distortion (THD) ≤ 0.3 %
Stereo separation > 50 dB

Connections

Interlock connector 2 BNC
Serial interface DB9 female RS232

5. Working Principles

A diagram view of the modules and connections making up the POS-300N series is shown as below.

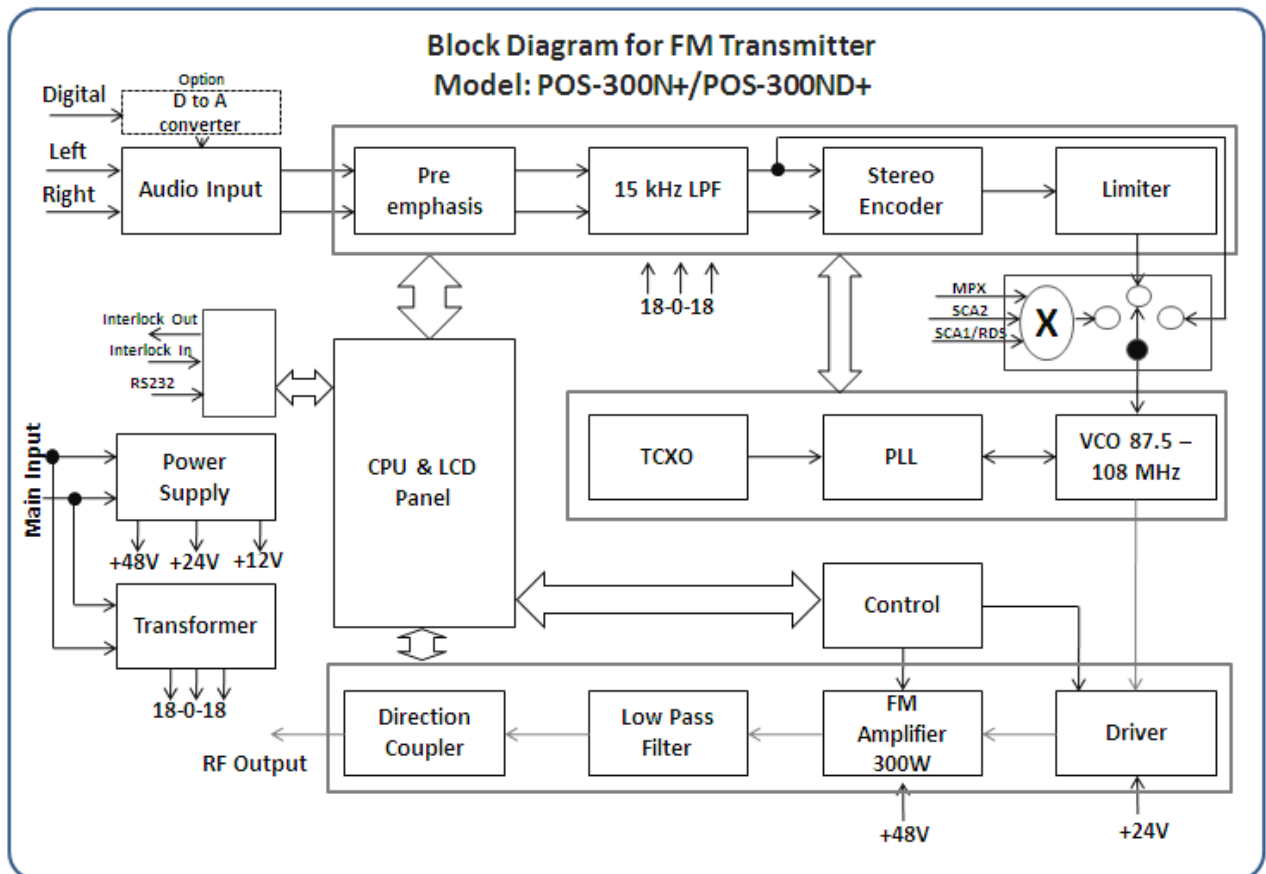



5.1 Power Supply

POS-300N series power supply is a switching type of unit, and its main +18V, -18V, 12V, 24V and 48 V output feeds the RF amplifier and regulate broad of the machine. The power supply is connected to voltage between 200 and 260 V without having to make adjustments or manual settings.

5.2 Main Board

The Main board contains the microcontroller (PIC18F6621) that implements the machine's control software, the display and the other components needed to interface the user. The board interfaces with the other machine modules, both for power supply distribution and for the control and measures.

5.3 Control Board

The control board contains the measure and control parameter (forward, reflect, voltage, current, temperature, bias etc.). The board interfaces with the other machine modules, both for LCD and power amplifier board.

5.4 Audio & VCO Board

The Audio & VCO board card carries out the following functions:

5.4.1 Encoder section

The encoder audio input section contains the circuits that perform the following functions:

- Input impedance selection
- 15 KHz filtering
- Pre emphasis selection
- Mixing of the signal, MPX and SCA channels
- Stereo multiplexing
- 19 KHz generate
- Measurement of the modulating signal
- Measurement of the left and right signal

5.4.2 PLL section

The PLL section of the card generates the signal in modulated radio frequency. It is based on a PLL diagram that uses an MC145170 type of integrated PLL. For frequency reference use to 10.000 MHz

5.4.3 VCO section

The VCO section of the card generates the signal in fm band 87.50 – 108 MHz. It is based on a VCO diagram that uses to varicap tuning diode and PHA-1 low noise amplifier.



5.5 Audio Con.

The connector needed to interface from audio signal and composite signal to audio & VCO board for transmitter.

5.6 Interface Con.

The interface connector needed to interface from machine and external machine for setup or monitoring.

5.7 Power Amplifier Board

The final power stage is enclosed in a totally shielded metal container fastened in the centre of the device. The RF signal coming from the VCO, is amplified and is then sent to the final stage that sees to its final amplifications up to 300W. The amplifier is made in three stages. The first is made with BGF35 and with one BLF244 and the last with one BLF278. In addition to the actual RF amplifier, this circuit carries out the following functions:

- Control of the power level in output, depending on the setting
- Measures direct and reflected power through directional couplers
- Low-pass filtering of the RF signal in output
- RF sample